

# Technical data sheet



Product features

## Chilled display unit GN 3-1/1 upwards opening

Model

SAP Code

00012124



<b>SAP Code</b>	00012124	<b>Net Weight [kg]</b>	190.80
<b>Net Width [mm]</b>	1169	<b>Power electric [kW]</b>	0.247
<b>Net Depth [mm]</b>	760	<b>Loading</b>	230 V / 1N - 50 Hz
<b>Net Height [mm]</b>	1688		

# Technical data sheet



Technical drawing

## Chilled display unit GN 3-1/1 upwards opening

Model

SAP Code

00012124

A= ELECTRICAL CONNECTION  
 D= WATER DISCHARGE Ø16  
 E= GAS CONNECTION Ø8 Ø10  
 F= WATER BOX

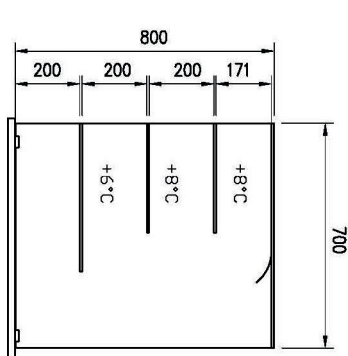
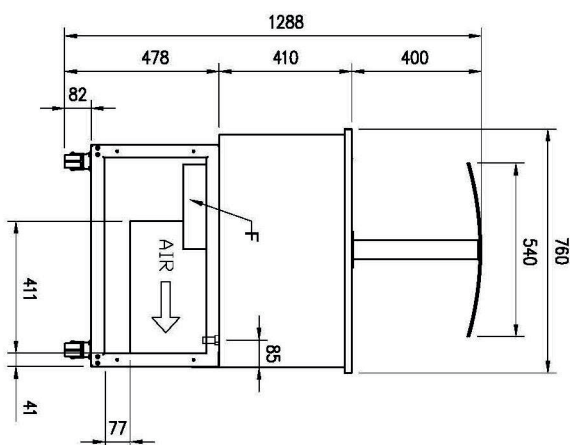
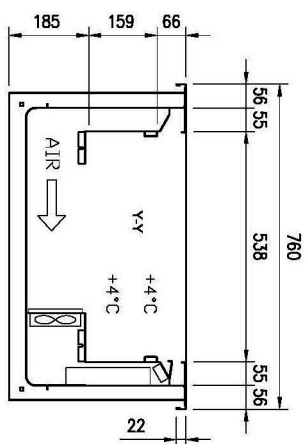
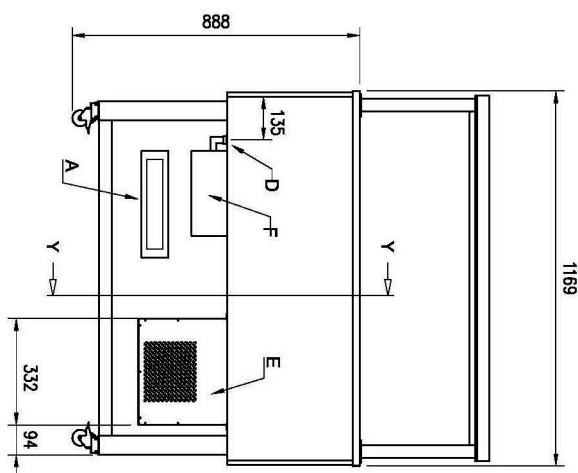
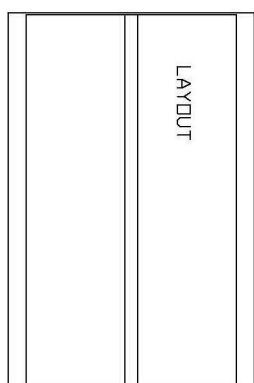

PLATINUM

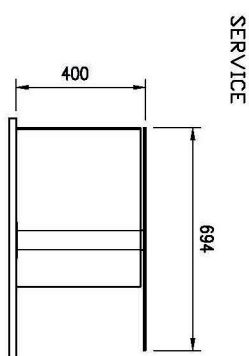

SERVICE

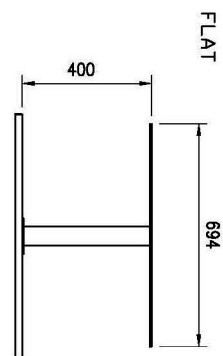

FLAT

# Technical data sheet



Technical parameters

## Chilled display unit GN 3-1/1 upwards opening

**Model**

**SAP Code**

00012124

**1. SAP Code:**

00012124

**7. Gross depth [mm]:**

860

**2. Net Width [mm]:**

1169

**8. Gross Height [mm]:**

1830

**3. Net Depth [mm]:**

760

**9. Gross Weight [kg]:**

213.00

**4. Net Height [mm]:**

1688

**10. Power electric [kW]:**

0.247

**5. Net Weight [kg]:**

190.80

**11. Loading:**

230 V / 1N - 50 Hz

**6. Gross Width [mm]:**

1233